

VOLTA- MODEL: ADDT45

WAC LIGHTING

4 " Square Narrow Recessed Angled Downlight

PROJECT:

TYPE:

Product Image

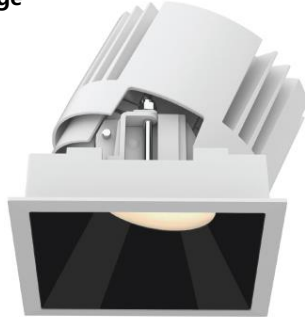

Line Drawing

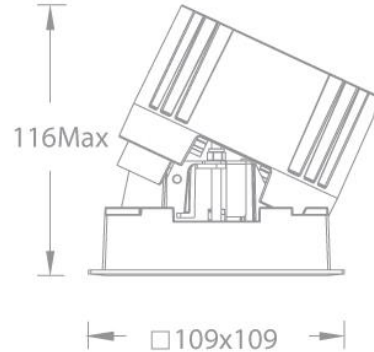

Product Description

VOLTA series LED square narrow edge embedded Angle downlight, streamlined appearance, using accurate lens and black mirror reflector design, to ensure light can still achieve the ultimate anti-glare effect, the whole Angle adjustment without noise; The light source cavity adopts the sealed design, which can minimize the influence of wet environment on its performance; It can also be freely disassembled and replaced with reflectors or accessories, greatly improving the convenience of the site, mainly for hotels and commercial indoor places.

Product Features

- **Body Material:** Aluminum alloy die-cast lamp body
- **Optical System:** Lens + reflector
- **Finish:** electrostatic powder spraying
- **Adjustable Angle:** Vertical adjustment 0-25°
- **Accessories:** see the attachment
- **Certification:** CCC
- **IP Rating:** IP20(Light source cavity IP44)
- **Insulation Level:** Class II
- **Operating Temperature:** -20°C~40°C

Product Specifications

- **Cut Out:** □100x100mm
- **Ceiling thickness:** 1mm~20mm
- **Lamp Shielding Angle:** 30°
- **LED Type:** COB
- **Source Lm:** 2700K: 8W 685lm; 13W 1380lm; 18W 1860lm
3000K: 8W 720lm; 13W 1465lm; 18W 1975lm
3500K: 8W 750lm; 13W 1540lm; 18W 2070lm
4000K: 8W 765lm; 13W 1600lm; 18W 2155lm
5000K: 8W 775lm; 13W 1645lm; 18W 2220lm
- **LED Lifetime:** >50000h-L70 /B10-Ta25°C(LM-80/TM-21)
- **CCT/CRI:** 2700K/3000K/3500K/4000K/5000K, CRI≥90
- **Input:** 220V AC / 50Hz
- **Dimming:** Non-dimming /0-10V/DALI(must be tested with the project site system in advance)
- **Net Weight:** Approx. 0.7Kg without packing

Order Model

Model	Size	Trim	LED	Driver	Beam	CCT	Reflector	Finish
ADDT Downlight Directional T series	4 4"	5 Square Trim	LD08 LED 8W	E On-Off D 0-10V Dimming	S 8°	27 2700K	B Black	WT White
			LM13 COB 13W		1 15°	30 3000K	S Specular	BK Black
			LM18 COB 18W	2 24°	35 3500K			
			LM18 COB 18W	3 36°	40 4000K			
				N No Driver A DALI	5 50°	50 5000K		

Example: ADDT45-LM18E230SWT

WAC Lighting
www.waclighting.com (US)
www.waclighting.net (International)

Headquarters
44 Harbor Park Drive • Port Washington, NY
Phone (516) 515.5000 • Fax (516) 515.5050

WAC Lighting Technology (Shanghai) Co, Ltd.
14,Lane 299, Bi Sheng Road,Shanghai 201204
Phone (86.21) 3393.3558 • Fax (86.21) 3362.1598

VOLTA- MODEL: ADDT45

WAC LIGHTING

4 " Square Narrow Recessed Angled Downlight

PROJECT:

TYPE:

Accessories

LENS-ADDT41-BEL Striped glass lens	LENS-ADDT41-HCL The endless bee net grid 
--	--

Note: Up to one optical accessory can be added, the factory is not equipped with accessories, need to order separately

LIGHT DISTRIBUTION @3000K DATA

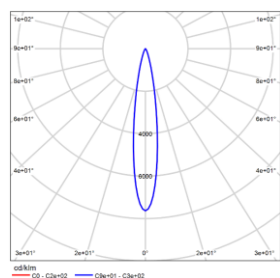
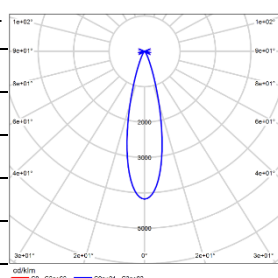
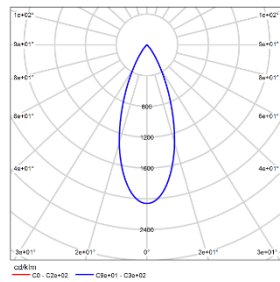
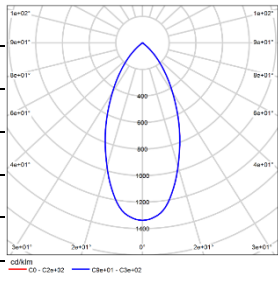
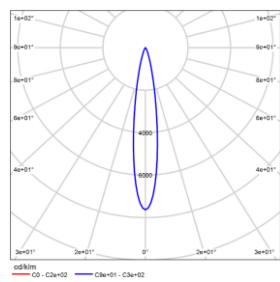
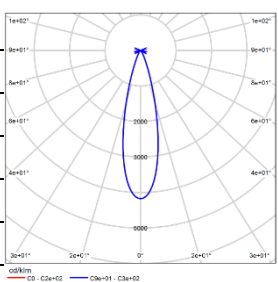
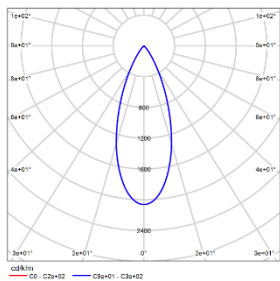
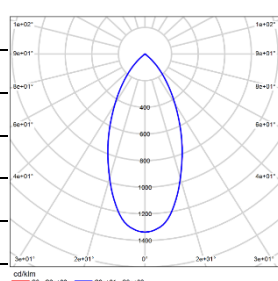
	MODEL: ADDT45-LM13EA130SWT BEAM ANGLE: 15° POWER: 15W LUMENS: 884lm CBCP: 6749cd EFFICACY: 59lm/W		MODEL: ADDT45-LM13E230SWT BEAM ANGLE: 24° POWER: 15W LUMENS: 1128lm CBCP: 4708cd EFFICACY: 75lm/W
	MODEL: ADDT45-LM13E330SWT BEAM ANGLE: 36° POWER: 15W LUMENS: 1204lm CBCP: 2482cd EFFICACY: 80lm/W		MODEL: ADDT45-LM13E530SWT BEAM ANGLE: 50° POWER: 15W LUMENS: 995lm CBCP: 1330cd EFFICACY: 66lm/W
	MODEL: ADDT45-LM18E130SWT BEAM ANGLE: 15° POWER: 22W LUMENS: 1258lm CBCP: 9597cd EFFICACY: 57lm/W		MODEL: ADDT45-LM18E230SWT BEAM ANGLE: 24° POWER: 21W LUMENS: 1604lm CBCP: 6695cd EFFICACY: 76lm/W
	MODEL: ADDT45-LM18E330SWT BEAM ANGLE: 36° POWER: 21W LUMENS: 1712lm CBCP: 3529cd EFFICACY: 82lm/W		MODEL: ADDT45-LM18E530SWT BEAM ANGLE: 50° POWER: 21W LUMENS: 1414lm CBCP: 1891cd EFFICACY: 67lm/W

VOLTA- MODEL: ADDT45

WAC LIGHTING

4 " Square Narrow Recessed Angled Downlight

PROJECT:

TYPE:

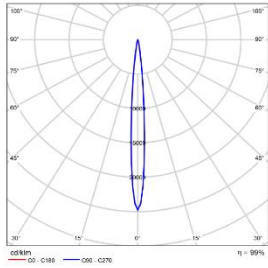

MODEL: ADDT45-LD08ES30SWT
BEAM ANGLE: 8°
POWER: 11W
LUMENS: 375lm
CBCP: 9280cd
EFFICACY: 34lm/W

WAC Lighting
www.waclighting.com (US)
www.waclighting.net (International)

Headquarters
44 Harbor Park Drive • Port Washington, NY
Phone (516) 515.5000 • Fax (516) 515.5050

WAC Lighting Technology (Shanghai) Co, Ltd.
14, Lane 299, Bi Sheng Road, Shanghai 201204
Phone (86.21) 3393.3558 • Fax (86.21) 3362.1598

WAC Lighting reserves the right to periodically design and update products. 2024-03-26

VOLTA- MODEL: ADDT55

WAC LIGHTING

5" Square Narrow Recessed Angled Downlight

PROJECT:

TYPE:

Product Image



Line Drawing

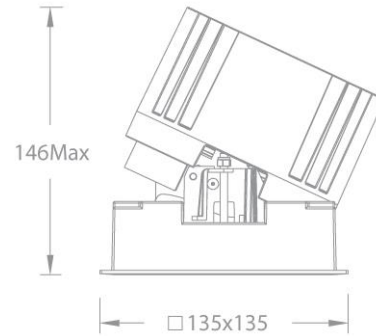

Product Features

- **Body Material:** Aluminum alloy die-cast lamp body
- **Optical System:** Lens + reflector
- **Finish:** electrostatic powder spraying
- **Adjustable Angle:** Vertical adjustment 0-25°
- **Accessories:** see the attachment
- **Certification:** CCC
- **IP Rating:** IP20(Light source cavity IP44)
- **Insulation Level:** Class II
- **Operating Temperature:** -20°C~40°C

Product Specifications

- **Cut Out:** □125x125mm
- **Ceiling thickness:** 1mm~25mm
- **Lamp Shielding Angle:** 30°
- **LED Type:** COB(Where 8° is HP LED)
- **Source Lm:** 2700K: 18W 1860lm; 25W 2460lm; 32W 3065lm
3000K: 18W 1975lm; 25W 2610lm; 32W 3255lm
3500K: 18W 2070lm; 25W 2710lm; 32W 3380lm
4000K: 18W 2155lm; 25W 2790lm; 32W 3480lm
5000K: 18W 2220lm; 25W 2870lm; 32W 3580lm
- **LED Lifetime:** >50000h-L70 /B10-Ta25°C(LM-80/TM-21)
- **CCT/CRI:** 2700K/3000K/3500K/4000K/5000K, CRI≥90
- **Input:** 220V AC / 50Hz
- **Dimming:** Non-dimming /0-10V/DALI(must be tested with the project site system in advance)
- **Net Weight:** Approx. 1.1kg without packing

Order Model

Model	Size	Trim	LED	Driver	Beam	CCT	Reflector	Finish
ADDT Downlight Directional T series	5 5"	5 Square Trim	LD24 LED 24W	E On-Off D 0-10V Dimming	S 8°	27 2700K	B Black	WT White
			LM18 COB 18W		1 15°	30 3000K	S Specular	BK Black
			LM25 COB 25W		2 24°	35 3500K		
			LM32 COB 32W	3 36°	40 4000K			
			LM32 COB 32W	5 50°	50 5000K			
				N No Driver A DALI				

Example: ADDT55-LM25E230SWT

WAC Lighting
www.waclighting.com (US)
www.waclighting.net (International)

Headquarters
44 Harbor Park Drive • Port Washington, NY
Phone (516) 515.5000 • Fax (516) 515.5050

WAC Lighting Technology (Shanghai) Co, Ltd.
14,Lane 299, Bi Sheng Road,Shanghai 201204
Phone (86.21) 3393.3558 • Fax (86.21) 3362.1598

VOLTA- MODEL: ADDT55

WAC LIGHTING

5" Square Narrow Recessed Angled Downlight

PROJECT:

TYPE:

Accessories

LENS-ADDT51-BEL Striped glass lens	LENS-ADDT51-HCL The endless bee net grid 
--	--

Note: Up to one optical accessory can be added, the factory is not equipped with accessories, need to order separately

LIGHT DISTRIBUTION @3000K DATA

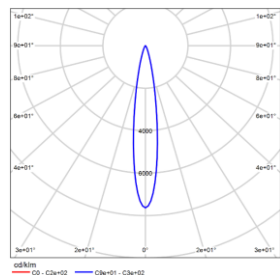
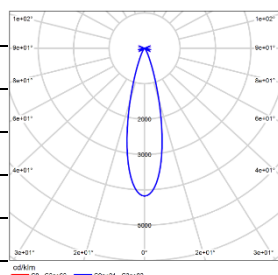
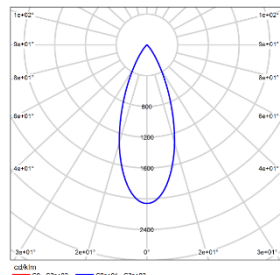
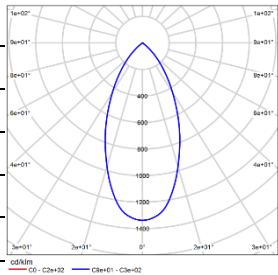
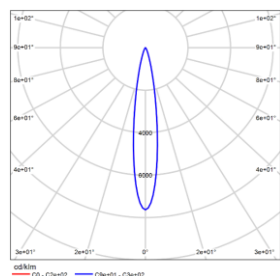
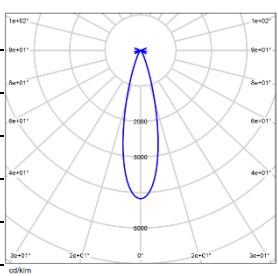
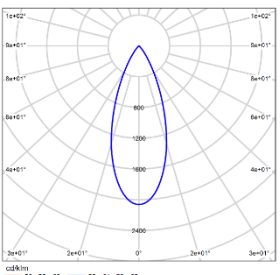
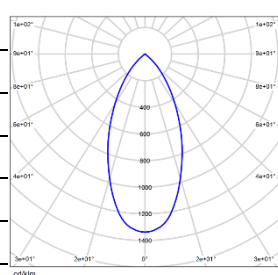
	MODEL: ADDT55-LM18E130SWT BEAM ANGLE: 15° POWER: 21W LUMENS: 1609lm CBCP: 14044cd EFFICACY: 77lm/W		MODEL: ADDT55-LM18E230SWT BEAM ANGLE: 24° POWER: 21W LUMENS: 1640lm CBCP: 6742cd EFFICACY: 78lm/W
	MODEL: ADDT55-LM18E330SWT BEAM ANGLE: 36° POWER: 21W LUMENS: 1783lm CBCP: 3738cd EFFICACY: 85lm/W		MODEL: ADDT55-LM18E530SWT BEAM ANGLE: 50° POWER: 21W LUMENS: 1538lm CBCP: 2311cd EFFICACY: 73lm/W
	MODEL: ADDT55-LM25E130SWT BEAM ANGLE: 15° POWER: 28W LUMENS: 2111lm CBCP: 18431cd EFFICACY: 75lm/W		MODEL: ADDT55-LM25E230SWT BEAM ANGLE: 24° POWER: 28W LUMENS: 2152lm CBCP: 8848cd EFFICACY: 77lm/W
	MODEL: ADDT55-LM25E330SWT BEAM ANGLE: 36° POWER: 28W LUMENS: 2340lm CBCP: 4905cd EFFICACY: 84lm/W		MODEL: ADDT55-LM25E530SWT BEAM ANGLE: 50° POWER: 28W LUMENS: 2018lm CBCP: 3033cd EFFICACY: 72lm/W

VOLTA- MODEL: ADDT55

WAC LIGHTING

5" Square Narrow Recessed Angled Downlight

PROJECT:

TYPE:

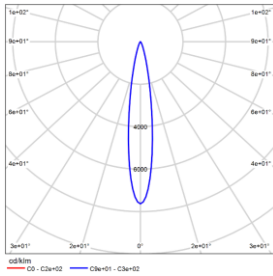

MODEL: ADDT55-LM32E130SWT
BEAM ANGLE: 15°
POWER: 35W
LUMENS: 2630lm
CBCP: 22965cd
EFFICACY: 75lm/W

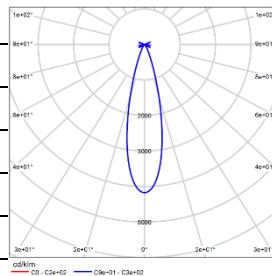

MODEL: ADDT55-LM32E230SWT
BEAM ANGLE: 24°
POWER: 35W
LUMENS: 2682lm
CBCP: 11024cd
EFFICACY: 77lm/W

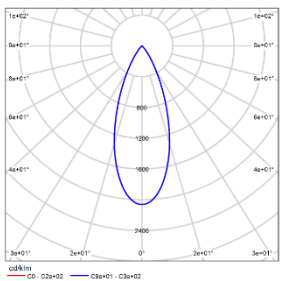

MODEL: ADDT55-LM32E330SWT
BEAM ANGLE: 36°
POWER: 35W
LUMENS: 2916lm
CBCP: 6112cd
EFFICACY: 83lm/W

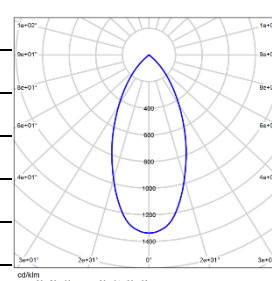

MODEL: ADDT55-LM32E530SWT
BEAM ANGLE: 50°
POWER: 35W
LUMENS: 2514lm
CBCP: 3779cd
EFFICACY: 72lm/W

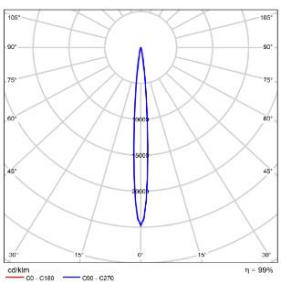

MODEL: ADDT55-LD24ES30SWT
BEAM ANGLE: 8°
POWER: 28W
LUMENS: 1125lm
CBCP: 27840cd
EFFICACY: 40lm/W

VOLTA- MODEL: ADDT65

WAC LIGHTING

6" Square Narrow Recessed Angled Downlight

PROJECT:

TYPE:

Product Image



Line Drawing

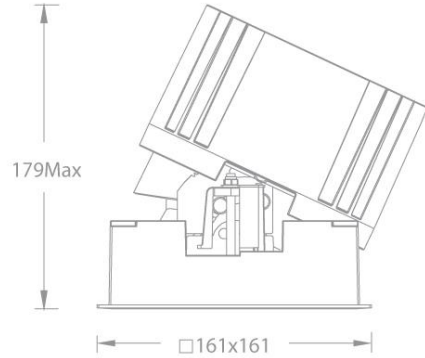

Product Features

- **Body Material:** Aluminum alloy die-cast lamp body
- **Optical System:** Lens + reflector
- **Finish:** electrostatic powder spraying
- **Adjustable Angle:** Vertical adjustment 0-25°
- **Accessories:** see the attachment
- **Certification:** CCC
- **IP Rating:** IP20(Light source cavity IP44)
- **Insulation Level:** Class II
- **Operating Temperature:** -20°C~40°C

Product Specifications

- **Cut Out:** □150x150mm
- **Ceiling thickness:** 1mm~30mm
- **Lamp Shielding Angle:** 30°
- **LED Type:** COB(Where 8° is HP LED)
- **Source Lm:** 2700K: 32W 2740lm; 25W 3610lm; 32W 4250lm
3000K: 32W 2880lm; 25W 3830lm; 32W 4505lm
3500K: 32W 3000lm; 25W 4020lm; 32W 4730lm
4000K: 32W 3060lm; 25W 4180lm; 32W 4920lm
5000K: 32W 3100lm; 25W 4310lm; 32W 5065lm
- **LED Lifetime:** >50000h-L70 /B10-Ta25°C(LM-80/TM-21)
- **CCT/CRI:** 2700K/3000K/3500K/4000K/5000K, CRI≥90
- **Input:** 220V AC / 50Hz
- **Dimming:** Non-dimming /0-10V/DALI(must be tested with the project site system in advance)
- **Net Weight:** Approx. 1.9Kg without packing

Order Model

Model	Size	Trim	LED	Driver	Beam	CCT	Reflector	Finish
ADDT Downlight Directional T series	6"	5 Square Trim	LD32 LED 32W	E On-Off D 0-10V Dimming	S 8°	27 2700K	B Black	WT White
			LM32 COB 32W		1 15°	30 3000K	S Specular	BK Black
			LM43 COB 43W	2 24°	35 3500K			
			LM43 COB 43W	3 36°	40 4000K			
				N No Driver A DALI	5 50°	50 5000K		

Example: ADDT65-LM43E230SWT

WAC Lighting
www.waclighting.com (US)
www.waclighting.net (International)

Headquarters
44 Harbor Park Drive • Port Washington, NY
Phone (516) 515.5000 • Fax (516) 515.5050

WAC Lighting Technology (Shanghai) Co, Ltd.
14,Lane 299, Bi Sheng Road,Shanghai 201204
Phone (86.21) 3393.3558 • Fax (86.21) 3362.1598

VOLTA- MODEL: ADDT65



WAC LIGHTING

6" Square Narrow Recessed Angled Downlight

PROJECT:

TYPE:

Accessories

LENS-ADDT61-BEL Striped glass lens		LENS-ADDT61-HCL The endless bee net grid	
--	---	--	---

Note: Up to one optical accessory can be added, the factory is not equipped with accessories, need to order separately

LIGHT DISTRIBUTION @3000K DATA

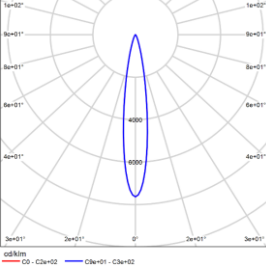
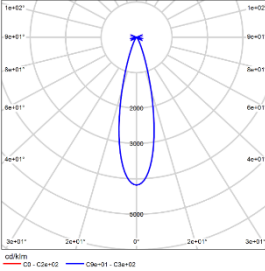
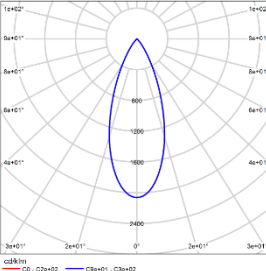
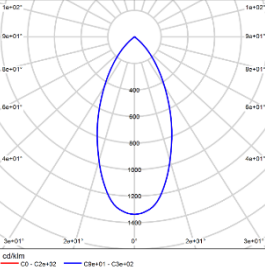
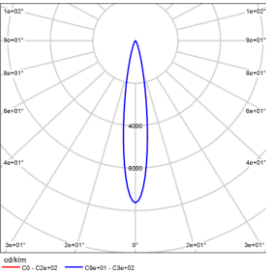
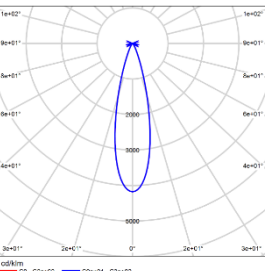
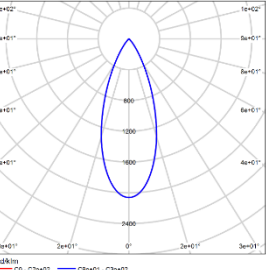
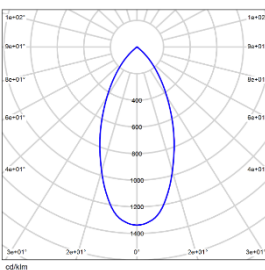
	MODEL: ADDT65-LM32E130SWT BEAM ANGLE: 15° POWER: 35W LUMENS: 2393lm CBCP: 23635cd EFFICACY: 68lm/W		MODEL: ADDT65-LM32E230SWT BEAM ANGLE: 24° POWER: 35W LUMENS: 3015lm CBCP: 13170cd EFFICACY: 86lm/W
	MODEL: ADDT65-LM32E330SWT BEAM ANGLE: 36° POWER: 35W LUMENS: 3001lm CBCP: 6651cd EFFICACY: 86lm/W		MODEL: ADDT65-LM32E530SWT BEAM ANGLE: 50° POWER: 35W LUMENS: 2830lm CBCP: 3762cd EFFICACY: 81lm/W
	MODEL: ADDT65-LM43E130SWT BEAM ANGLE: 15° POWER: 47W LUMENS: 3108lm CBCP: 30695cd EFFICACY: 66lm/W		MODEL: ADDT65-LM43E230SWT BEAM ANGLE: 24° POWER: 47W LUMENS: 3916lm CBCP: 17104cd EFFICACY: 83lm/W
	MODEL: ADDT65-LM43E330SWT BEAM ANGLE: 36° POWER: 47W LUMENS: 3897lm CBCP: 8638cd EFFICACY: 83lm/W		MODEL: ADDT65-LM43E530SWT BEAM ANGLE: 50° POWER: 47W LUMENS: 3675lm CBCP: 4885cd EFFICACY: 78lm/W

VOLTA- MODEL: ADDT65

WAC LIGHTING

6" Square Narrow Recessed Angled Downlight

PROJECT:

TYPE:

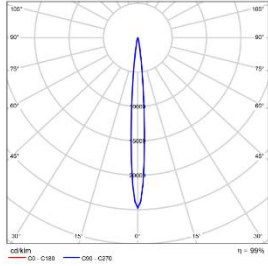

MODEL: ADDT65-LD32ES30SWT
BEAM 8°
ANGLE: 35W
POWER: 1500lm
LUMENS: 37120cd
CBCP: 43lm/W